

Aanvullend hijsgereedschap

Kubels (ook zijlossers)

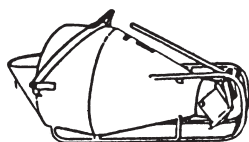

500 - 2000 ltr

Blokken/elementenklemmen

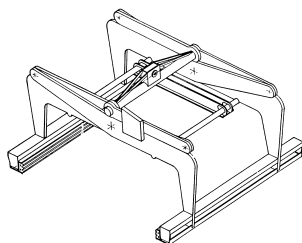

klembreedte	75-105 cm
klemlengte	120 cm
klemhoopte	38/18 cm
max. last	1200/1500 kg
eigen gewicht	230/150 kg

Tegelklem

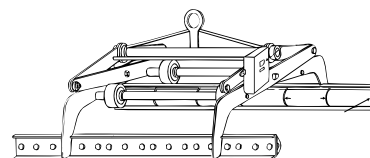

klembreedte	40-65 cm
klemlengte	180 cm 200 cm
klemhoopte	20 cm
max. last	1500 kg 1200 kg
eigen gewicht	200 kg

Vloerplatenklemmen

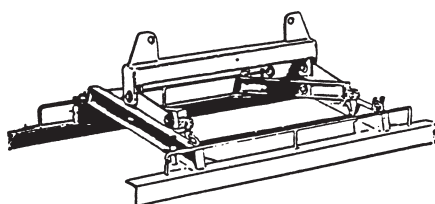

klembreedte	30-120	120 cm
klemlengte	200	175-350 cm
max. last	3000	4000 kg
eigen gewicht	190	300 kg
max. lengte plaat	700 cm	

Zelflossende stortcontainer

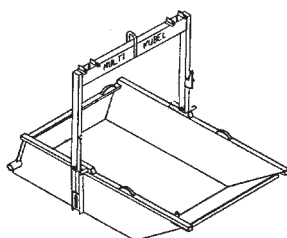

max. last	2000 kg
eigen gewicht	200 kg
inhoud	1 m ³
afmetingen	215/230x100x57 cm

Deha/Frimedahaken

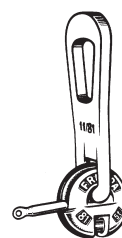

1 - 10 ton/1,25 - 22 ton

Werkbakken

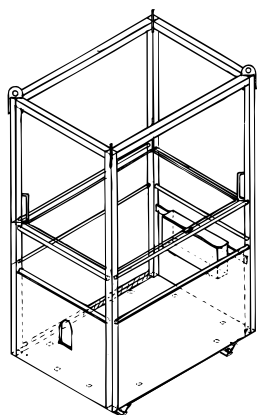

max. last	200/250 kg	250 kg	500 kg
lengte	130/150 cm	150 cm	400 cm
breedte	90/80 cm	120 cm	90 cm
eigen gewicht	300/240 kg	300 kg	510 kg
aantal personen	2	2	3

Verstelbare palletshaken

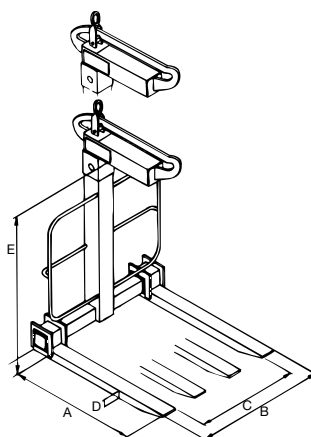

max. last	2000 kg
eigen gew.	190/150 kg
vorklengte	97 cm
vorkbreedte max.	95 cm
inw. hoogte max.	190 cm
vorkafmetingen	16,6 x 3,4 of 10 x 4 cm

Halve/dubbele gevelstenentang

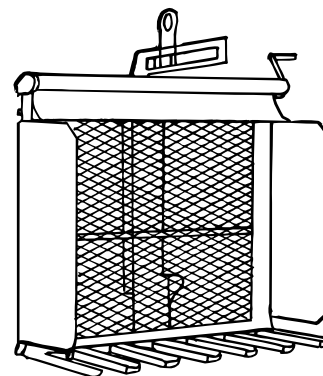

bordesbreedte	125 cm
bordeshoogte	109 cm
aantal werkende tanden	6
tandlengte	43 cm
tandhoogte	3,2 cm
tandbreedte	7 cm

Hijsbalken, variabel

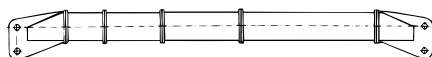

10 ton	uitschuifbaar	2,5 - 4,25 m
20 ton	max.	2 x 10 of 1 x 12 m
200 ton	max.	2 x 10 of 1 x 18,75 m

Verstelbare kruishijsbalk 40 t.

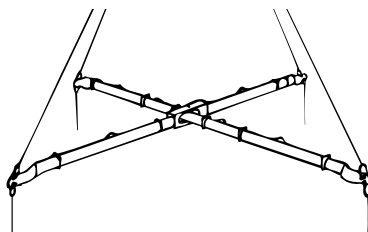

lengte balken	max. 11,5 m
---------------	-------------

Unidek HD-dakelementenklem

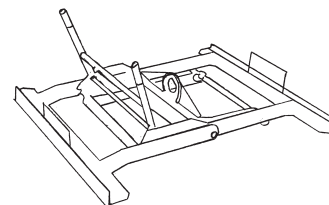

max. last	300 kg
klembreedte	99 - 100 cm
klemlengte	100 cm